

# Herramientas para 3d Modeling



*DS Solidworks*



*Autodesk Maya*



*Autodesk Alias*



*Autodesk Inventor*



*Autodesk 3DS Max*



*Z-brush*



*Blender*



*DS Catia*



*Google Sketchup*

# 3D Modeling

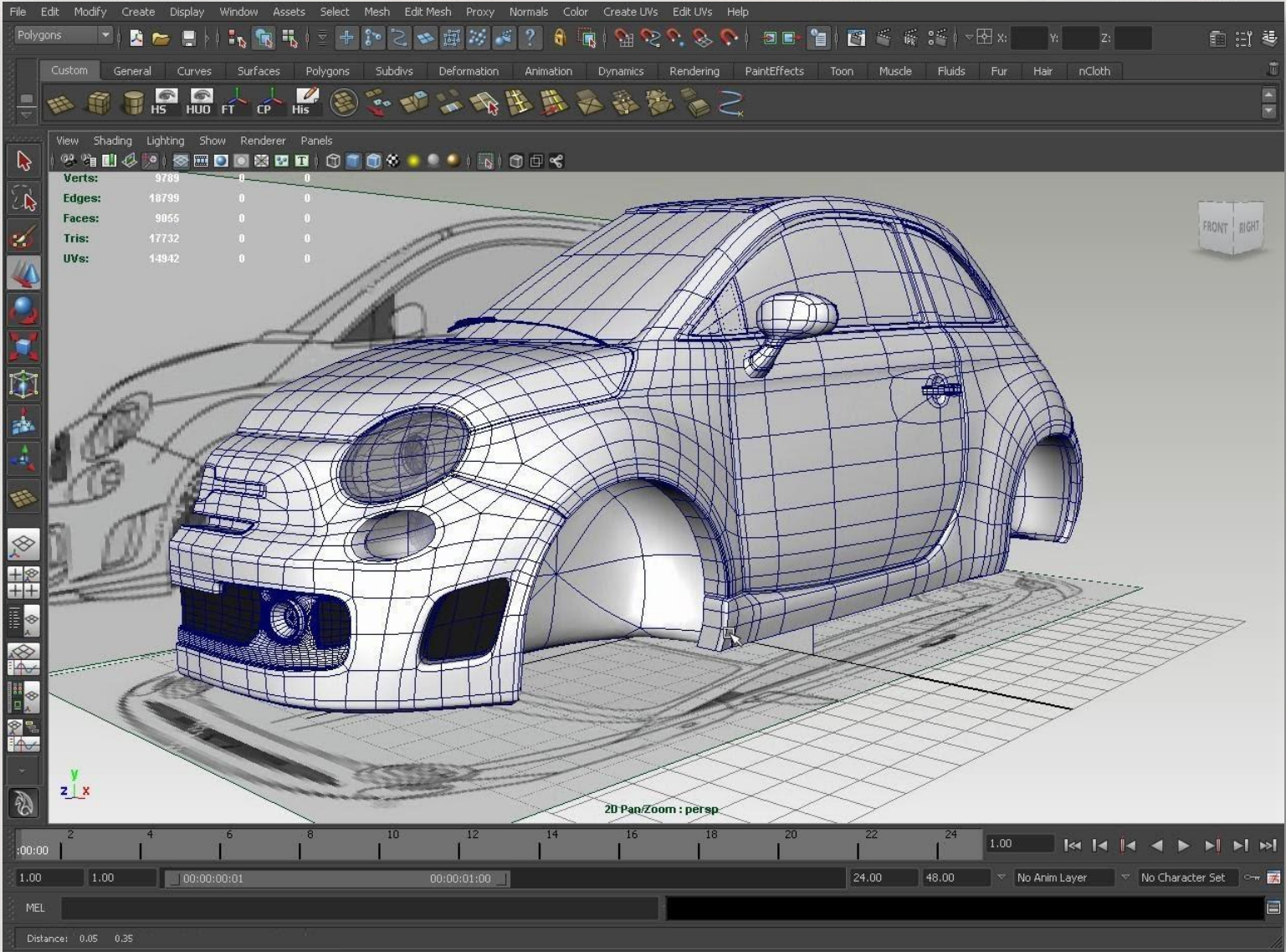

# Técnicas de 3D Modeling

- *Trabajo por Vistas y superficies*
- *Trabajo por moldeado*
- *Simulación*

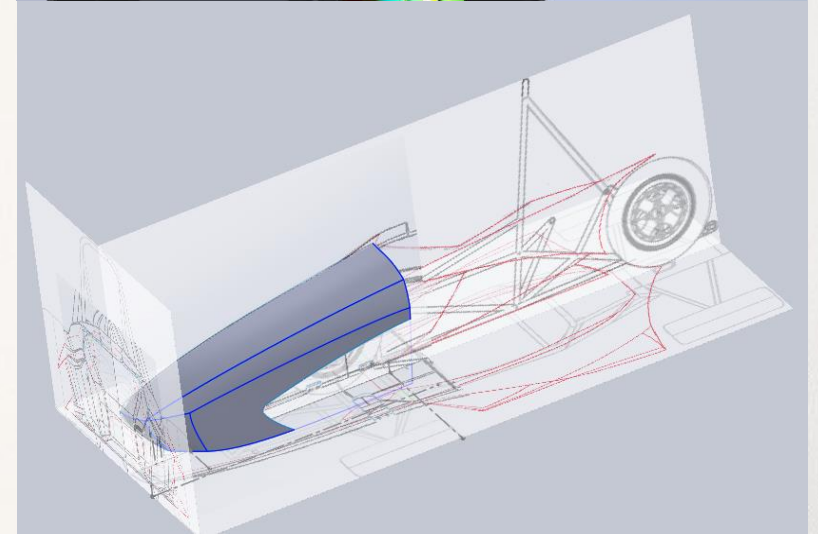
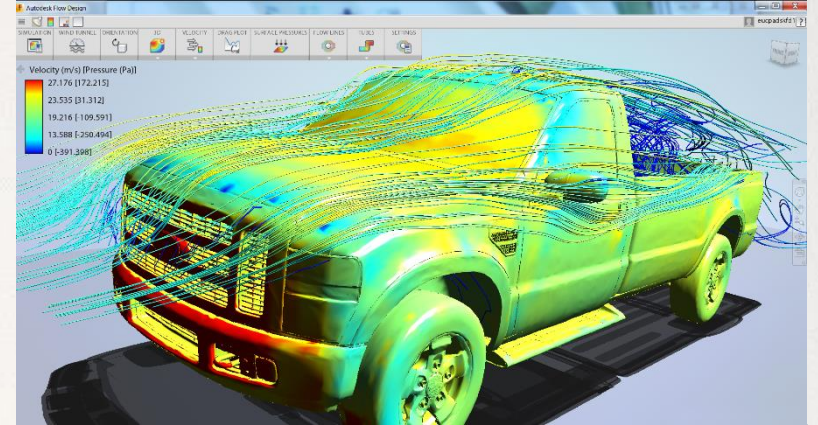

*Rendering 3D*



# *Ejemplos de 3D Modeling*



[www.BoldRide.com](http://www.BoldRide.com)

# Ejemplos de 3D Modeling



# Clay Modeling (Escala 1/4)



# Clay Modeling (Escala 1/1)





# Herramientas para Clay Modeling

- Arcilla húmeda
- Gubias, Espátulas y demás
- Planos de referencia
- Fresadora CNC
- Impresora 3D
- Scanner 3D



# *Ejemplos de Clay Modeling*



# Ejemplos de Clay Modeling



# *Ejemplos de Clay Modeling*



# *Ejemplos de Clay Modeling*

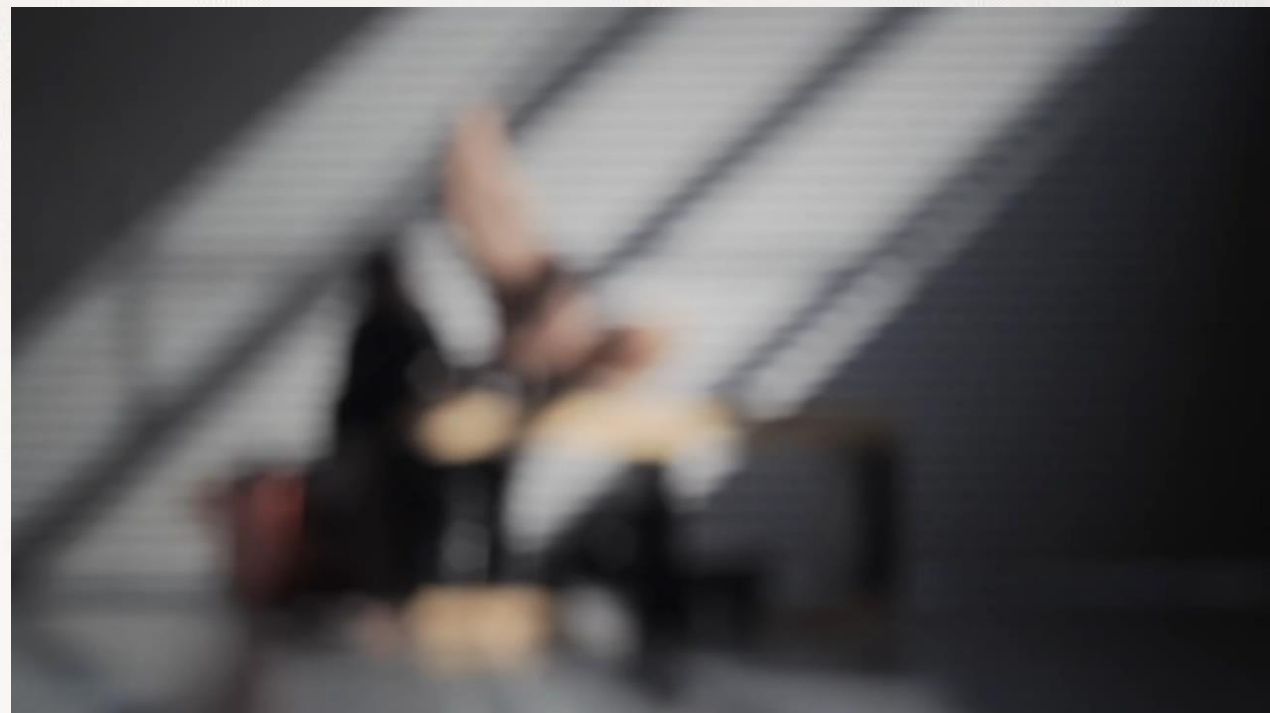
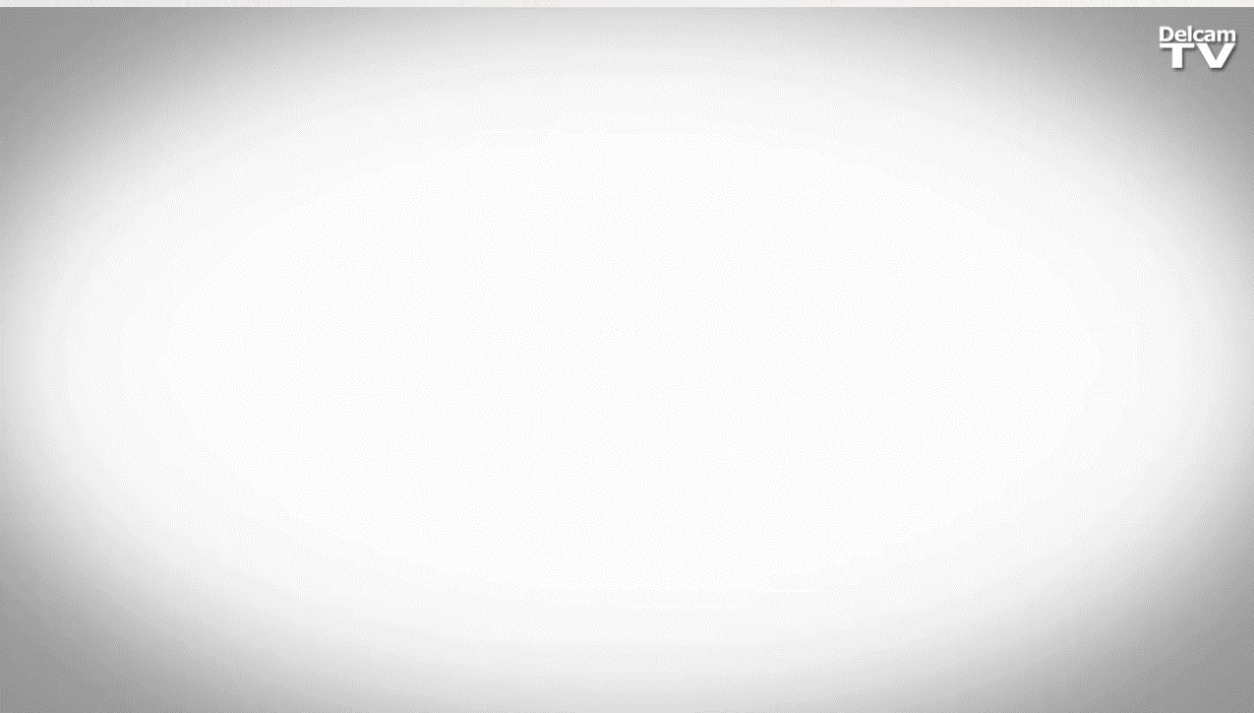

# Clay Modeling



# *Showroom*

*Salon de Ginebra*

*Paris Motor Show & Frankfurt motor show*

*Shanghai design Saloon*

*SEMA (Las Vegas Convention Centre)*

# Showroom







SPEED HUNTERS LOUIS YIO



SPEED HUNTERS DINO DALLE CARBONARE



# Conceptualización

NetCarShow.com

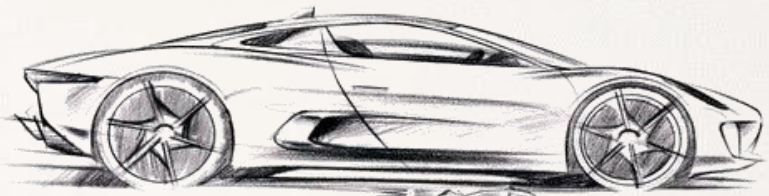
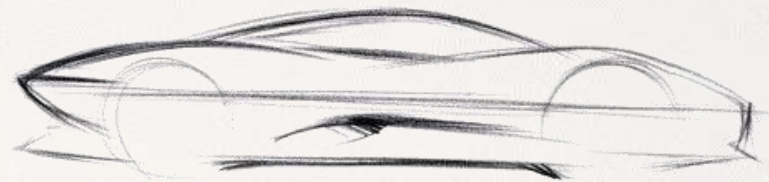
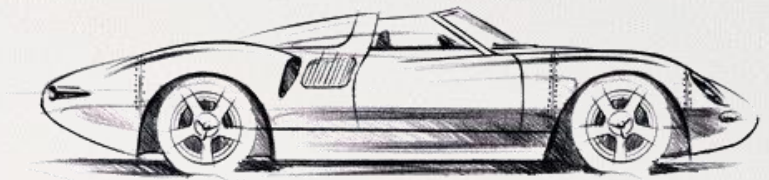
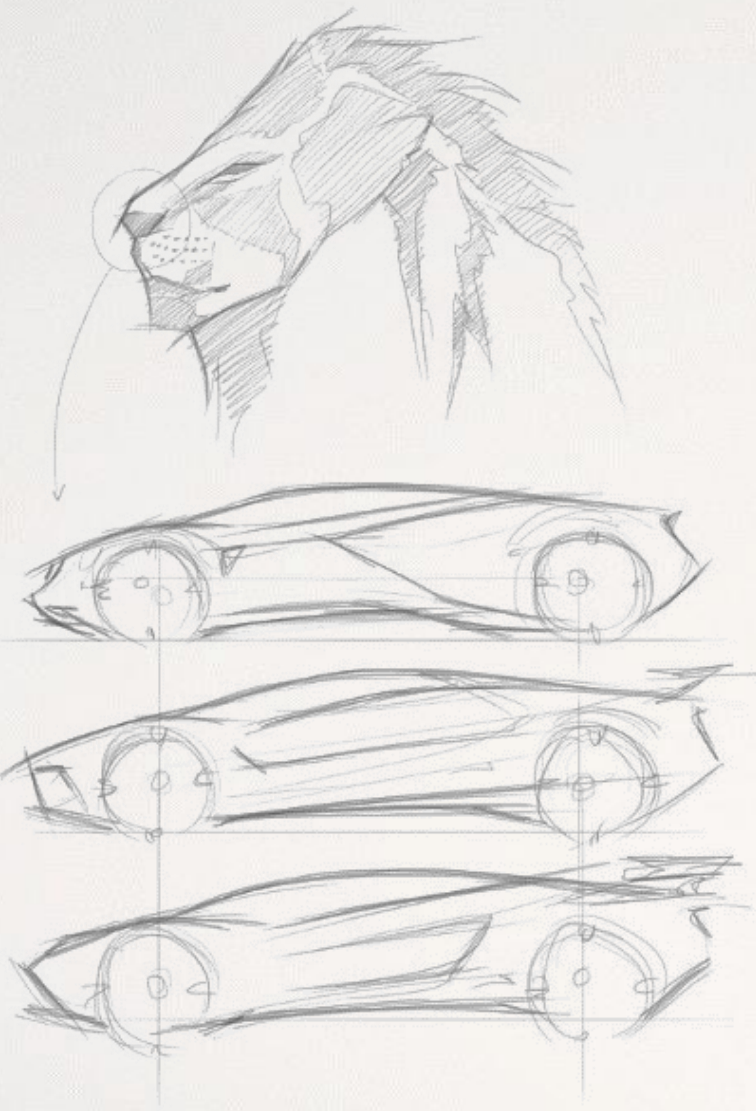

NetCarShow.com

*Biónica*

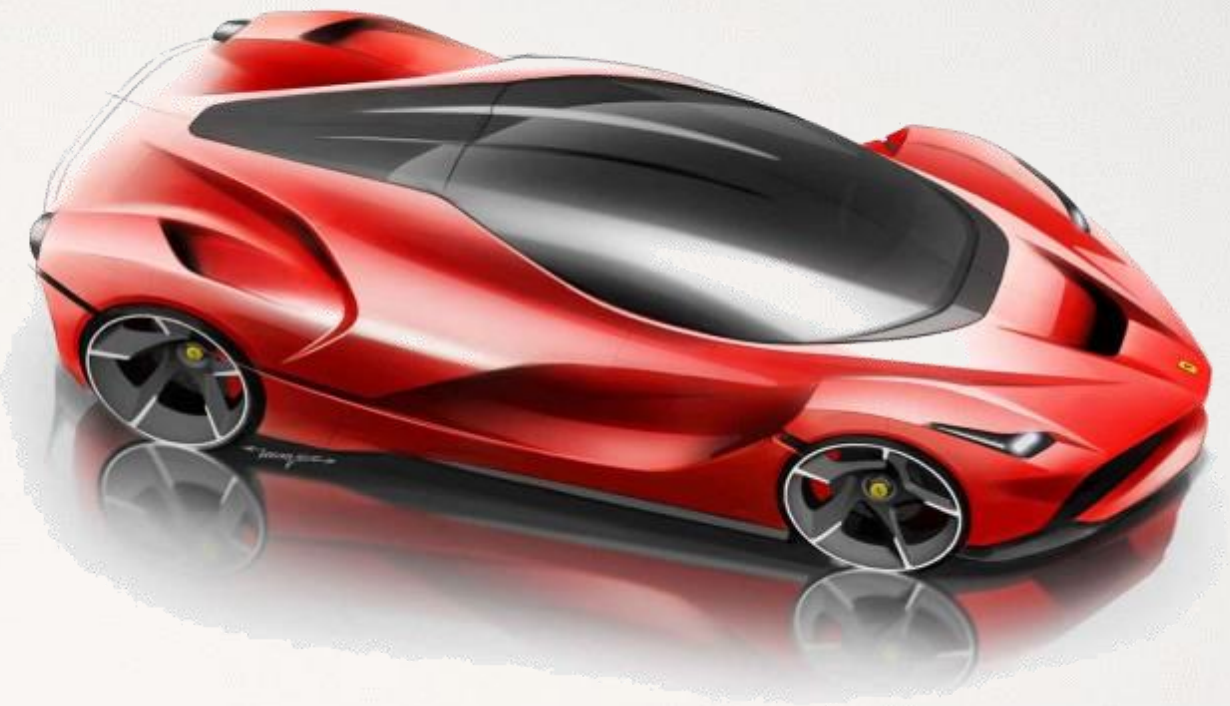
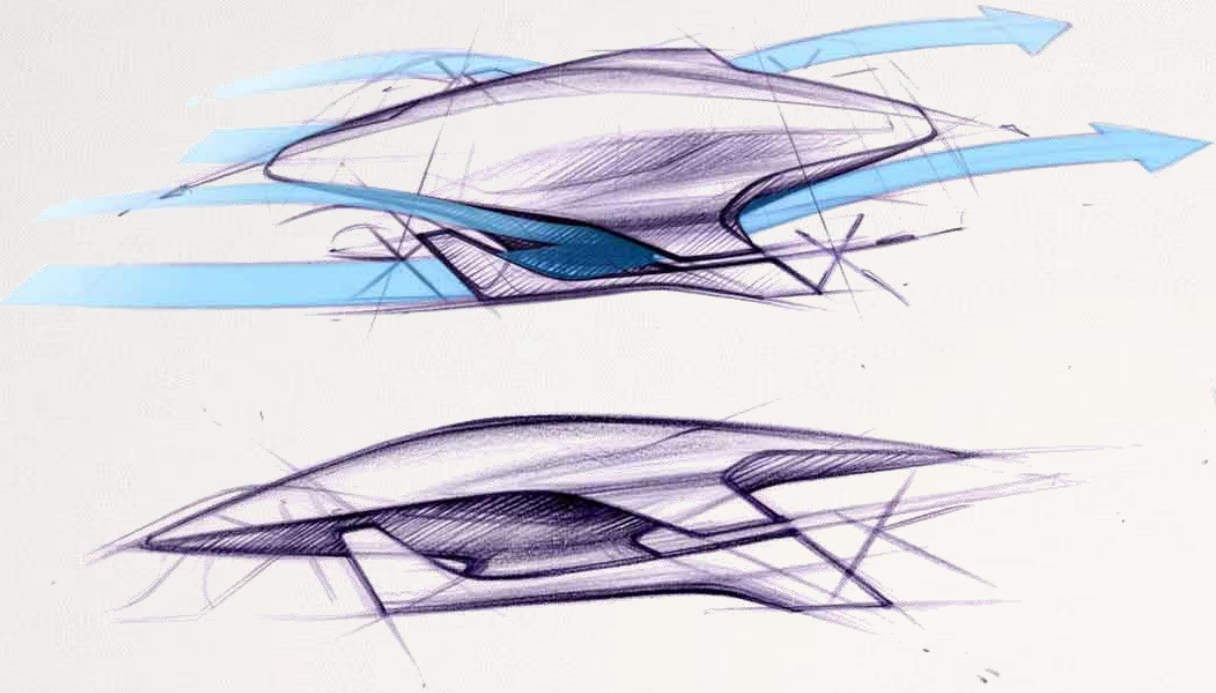

F1

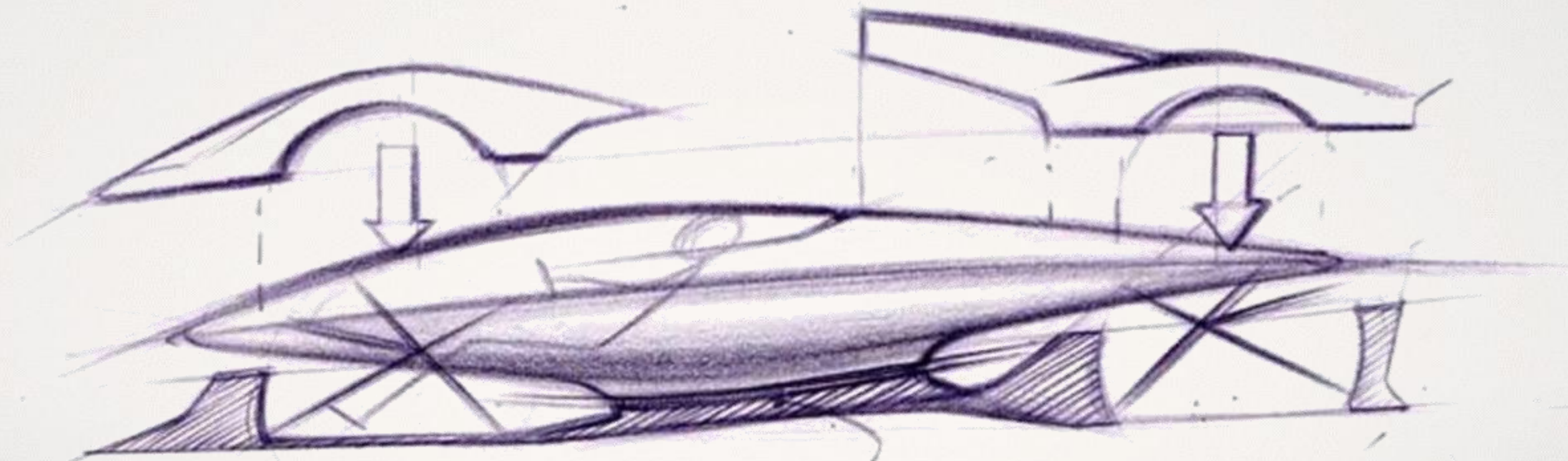
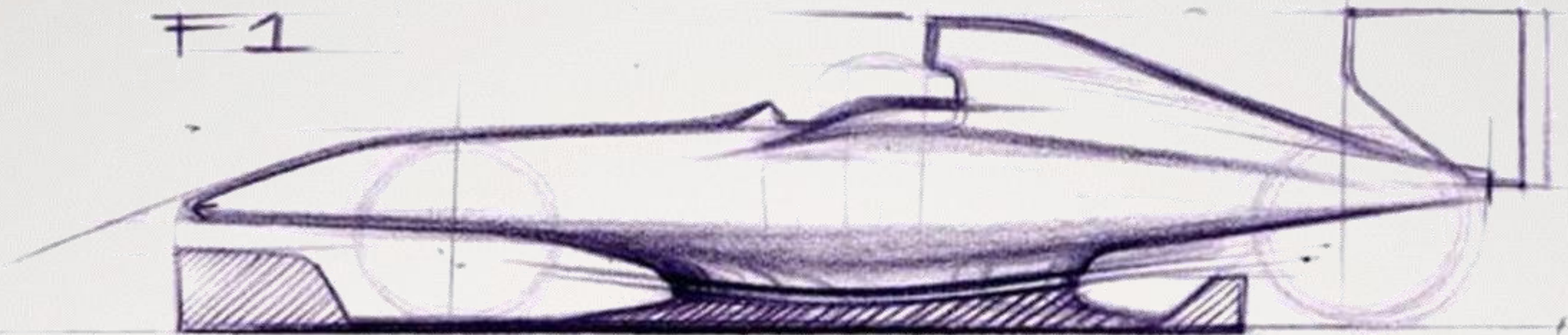

CARBON FIBER

# Conceptualización

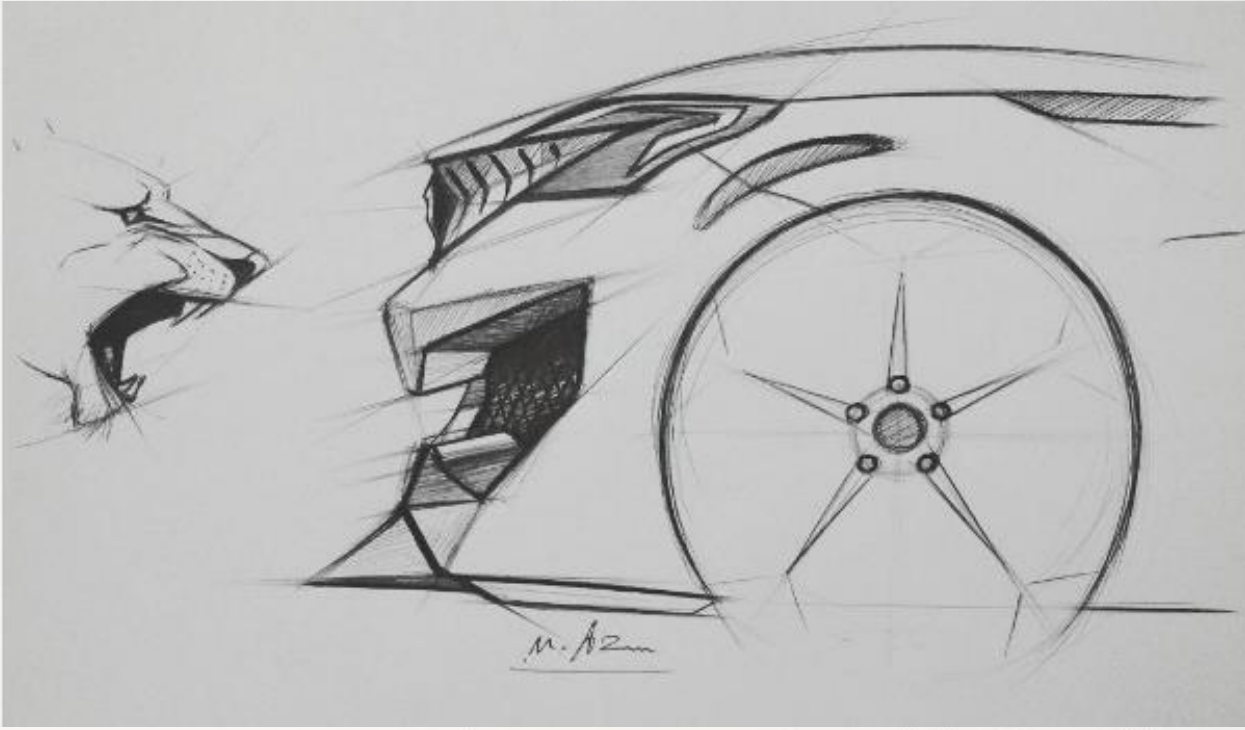
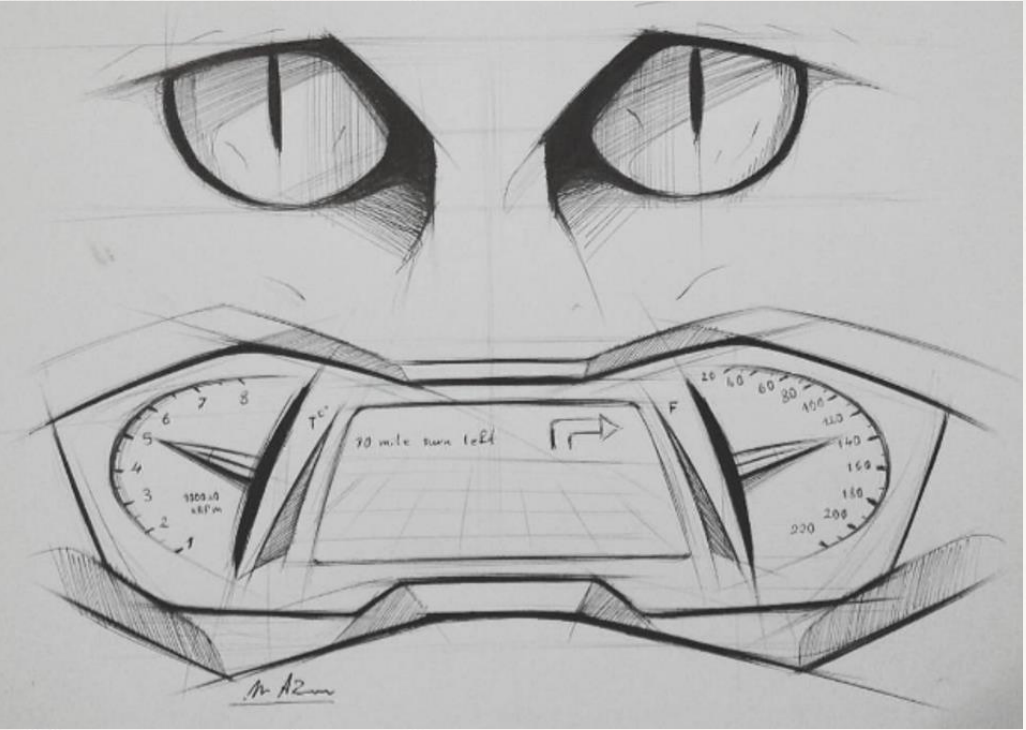

*Biónica*

# Conceptualización



*Biónica*

# Conceptualización



*Biónica*

DIAMANTE





# Conceptualización



*Biónica*

# Conceptualización

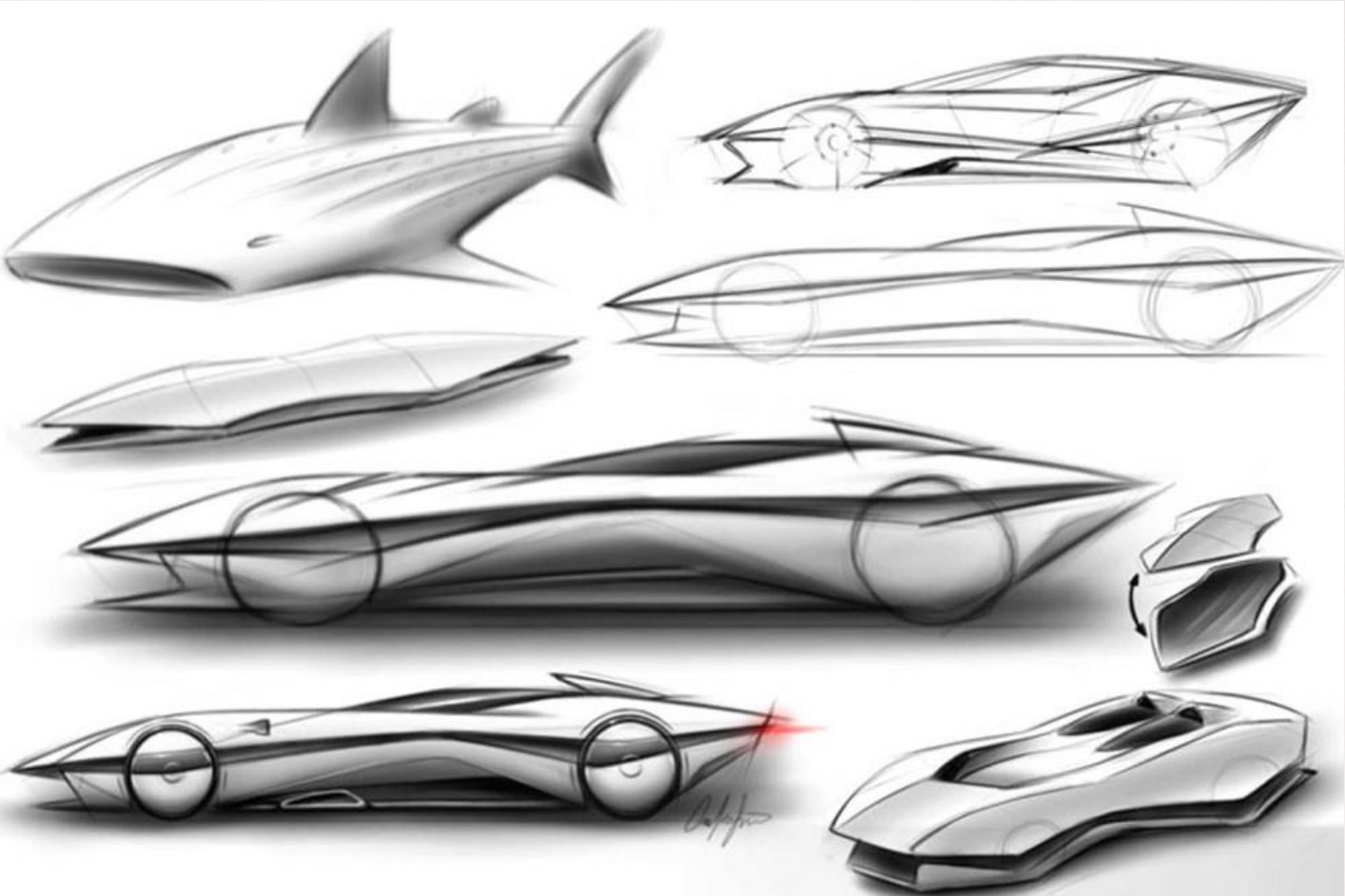

*Biónica*

DISCLAIMER: All logos or names are not used for profit and they belong to the manufacturer mentioned in the illustration. This content is for private use only. DESIGN: maffeoandfelloworks.blogspot.com

# Conceptualización



*Biónica*

# Conceptualización



*Biónica*

# Conceptualización

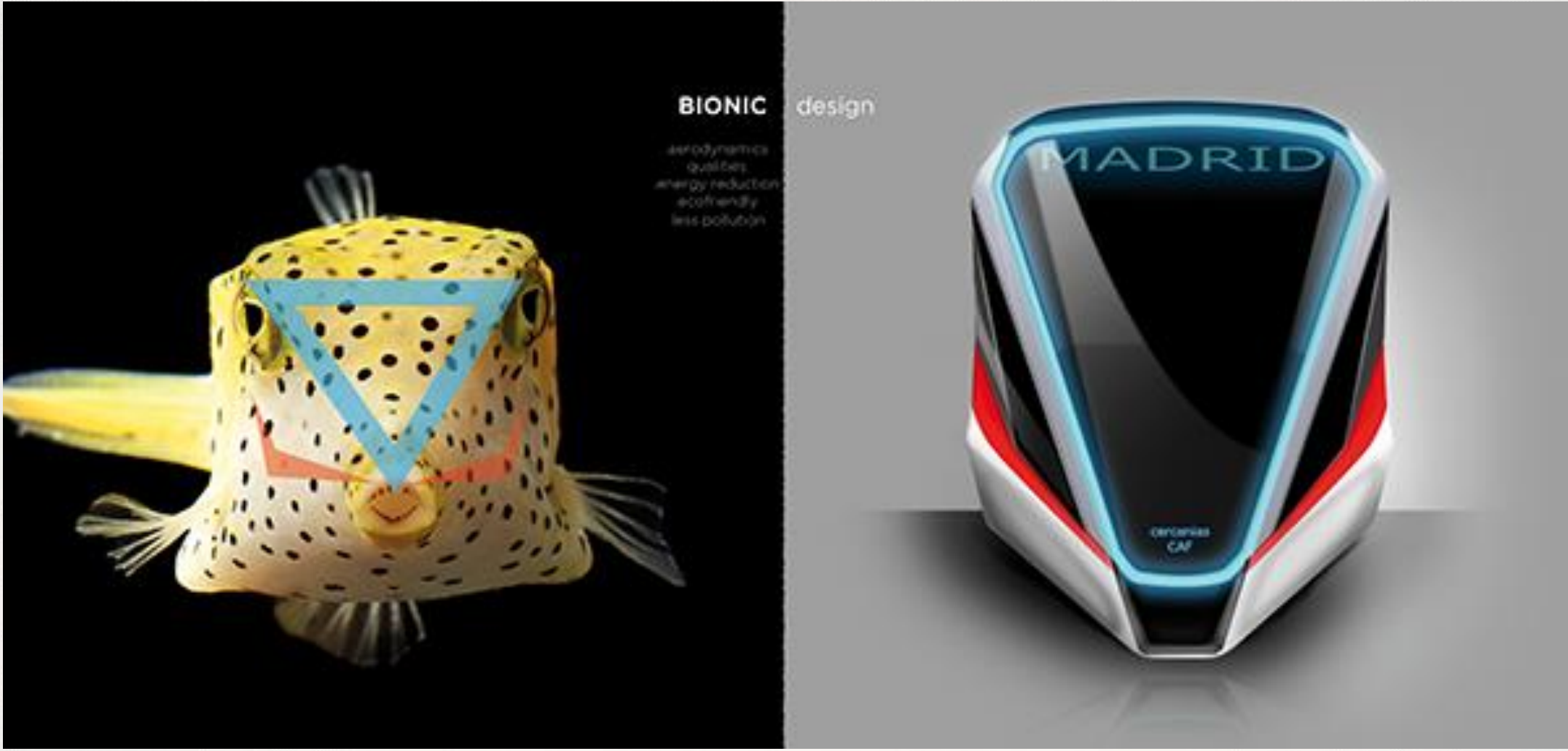

*Biónica*

# Conceptualización

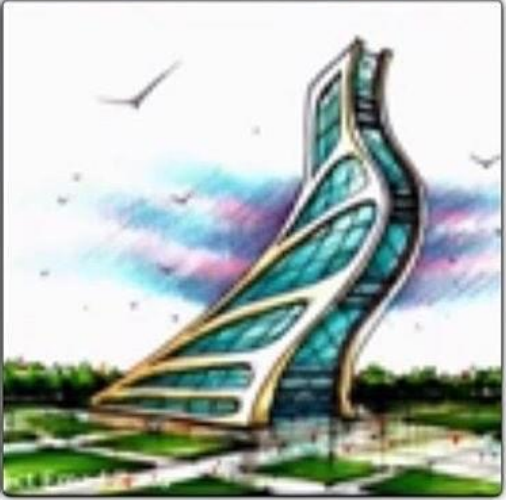
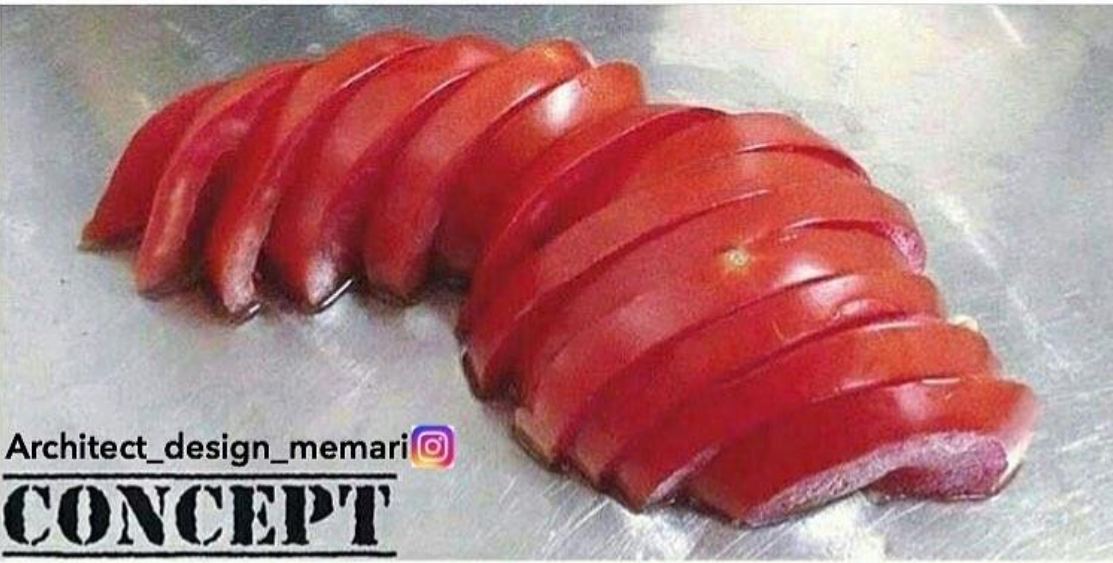

*Biónica*

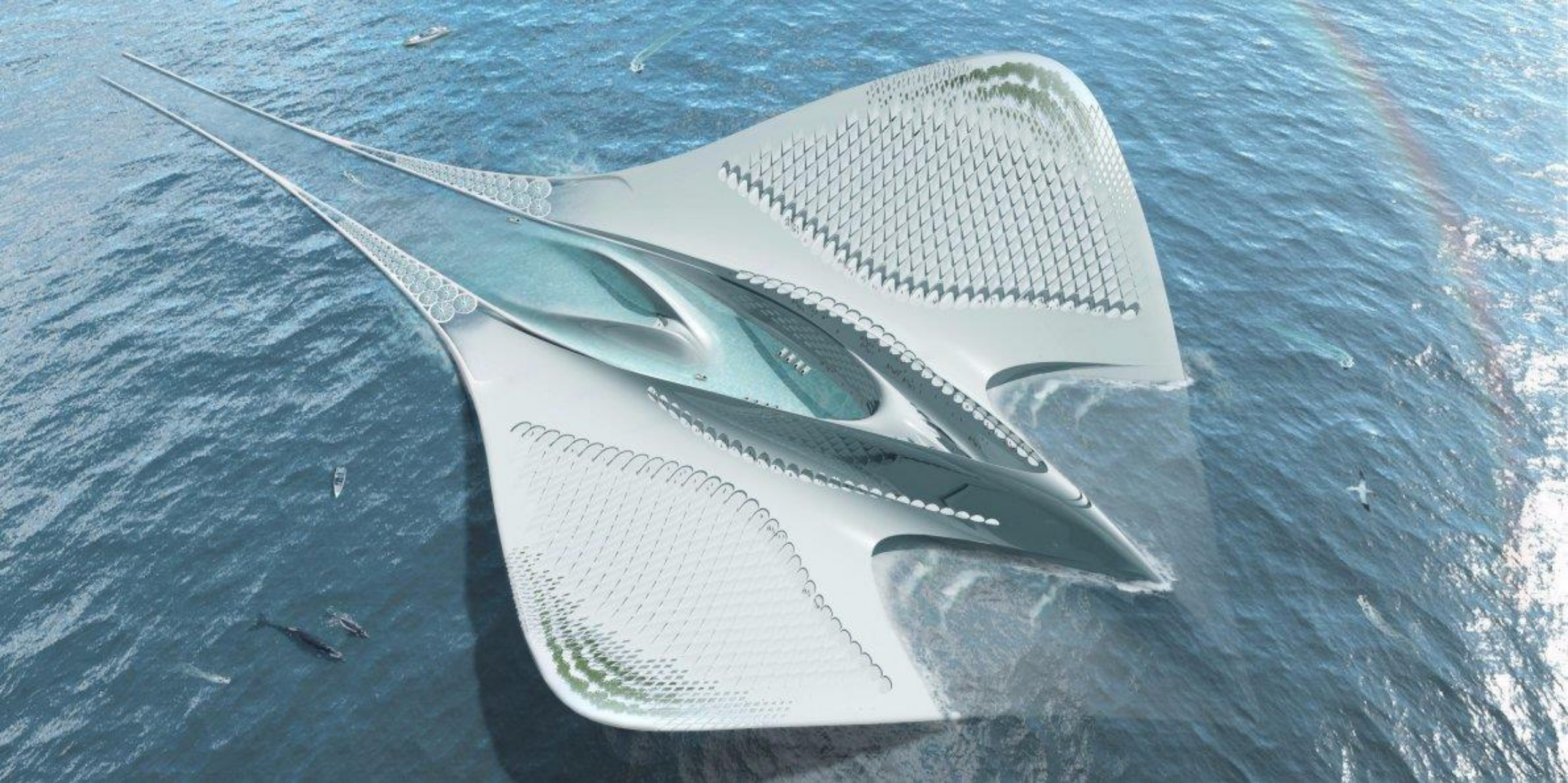

*Biónica*

# Conceptualización



BMW  
2002 REVISION



*Yasid*

4D YASIDDESIGN

FACEBOOK.COM/YASIDDESIGN



# Conceptualización

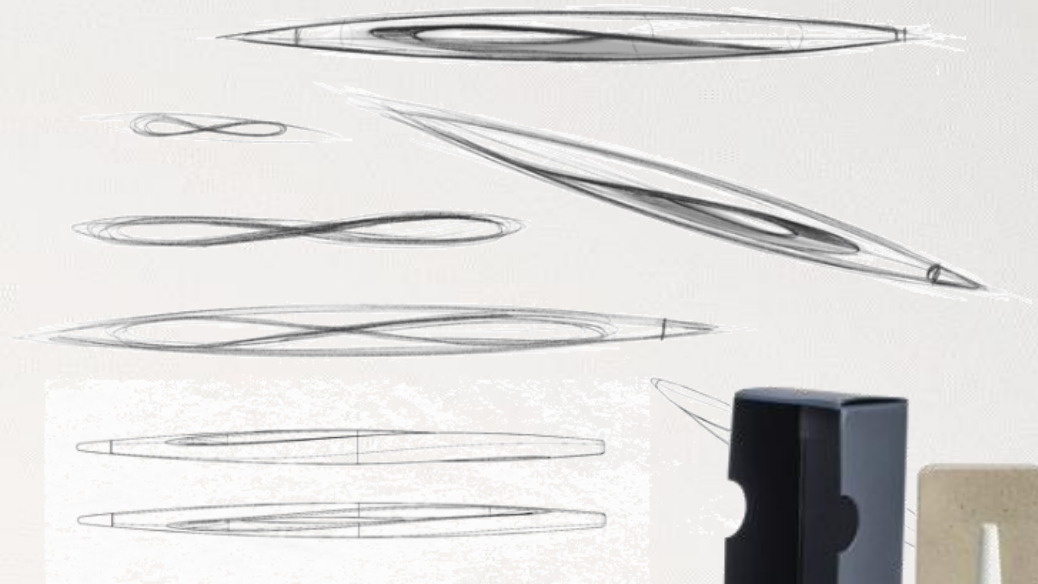

*Biónica*

# Conceptualización



*Biónica*

# Conceptualización

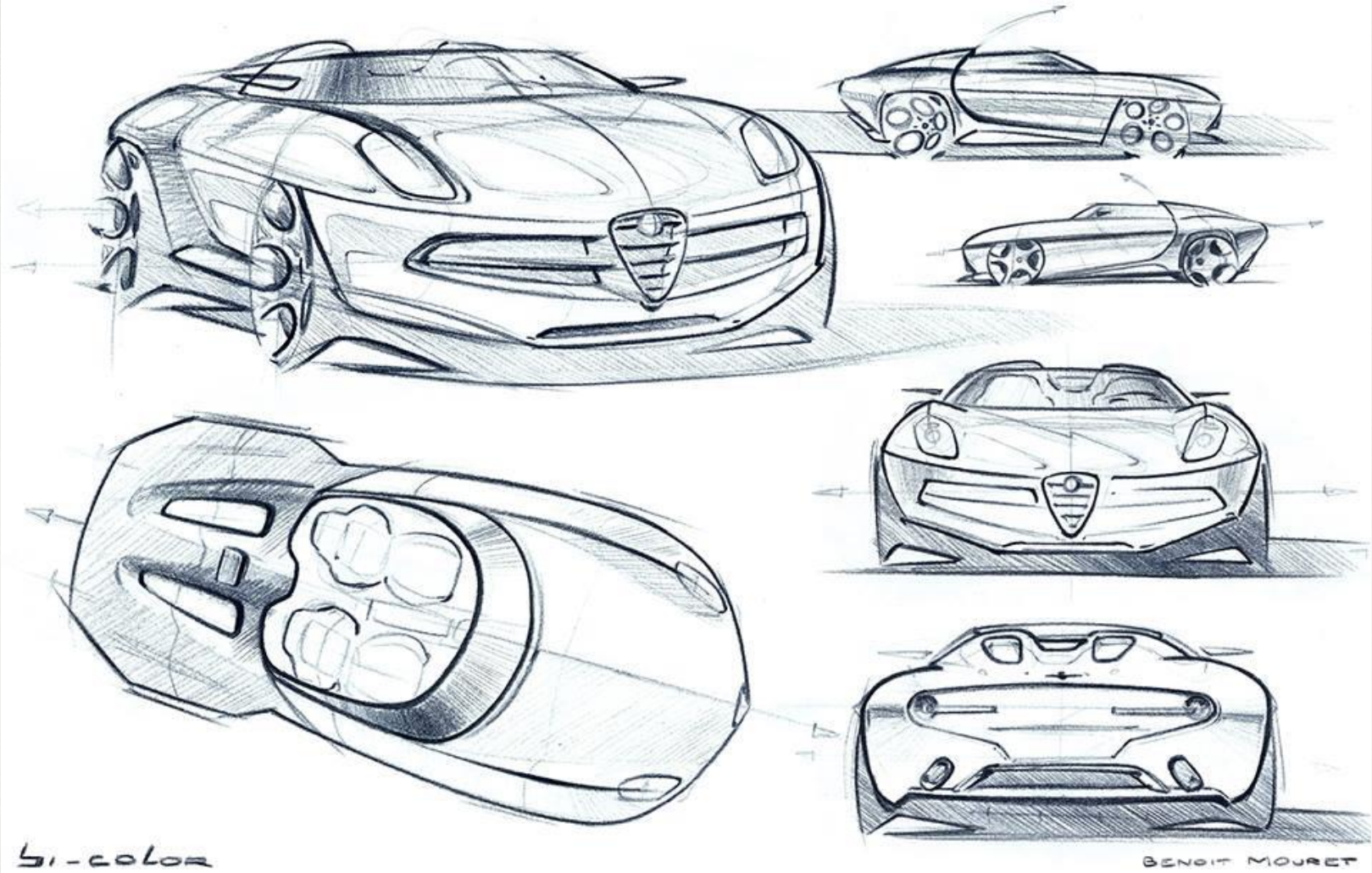

*Biónica*

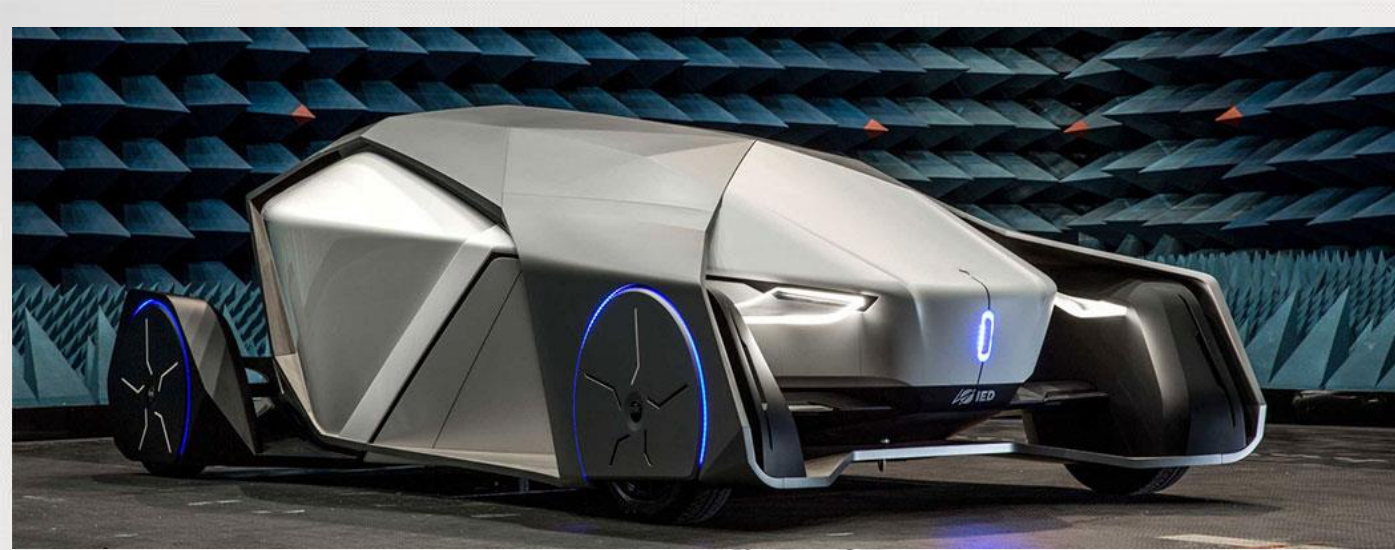

DESK

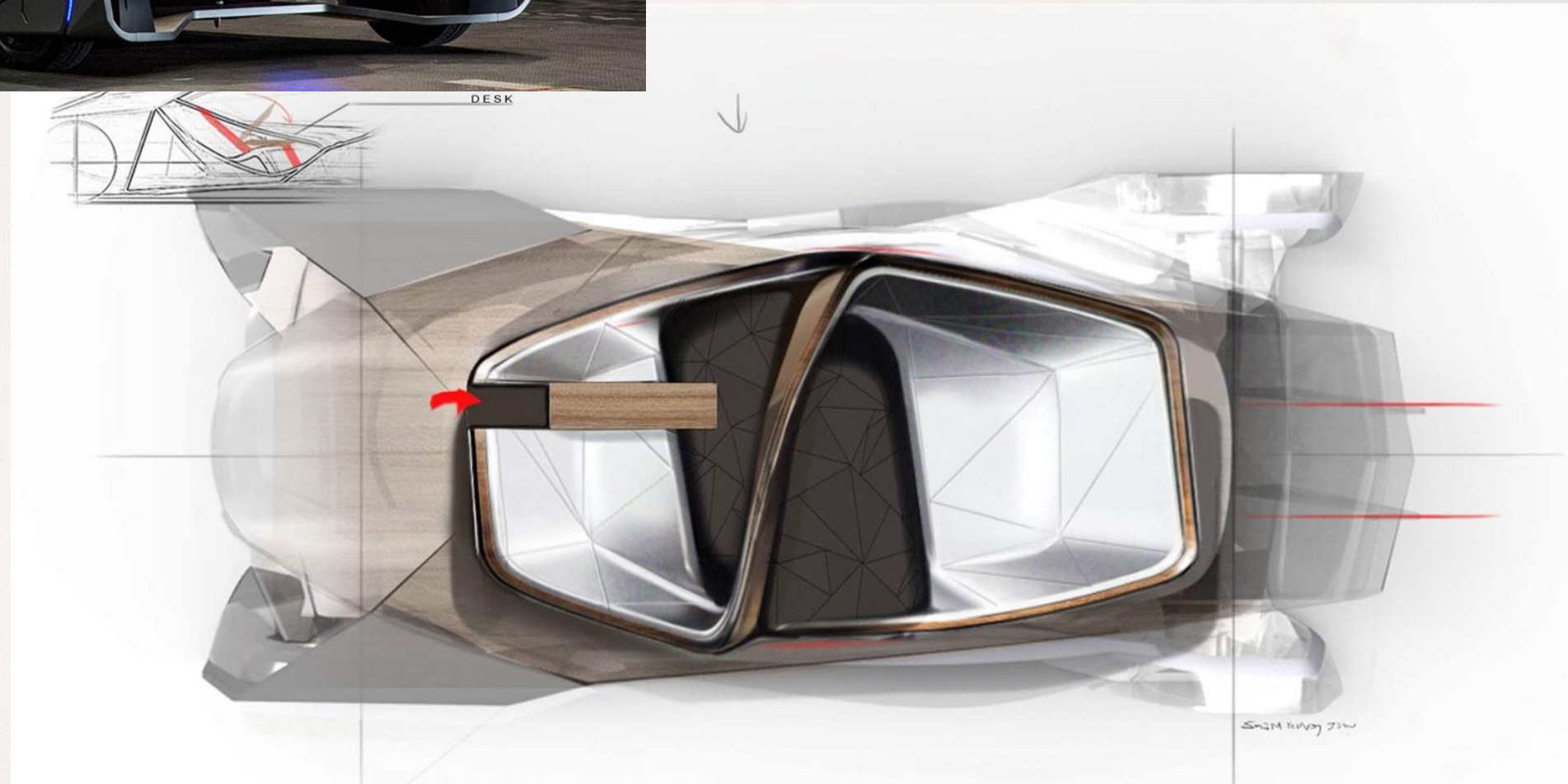

SMITH KILPATRICK 2014



# Conceptualización

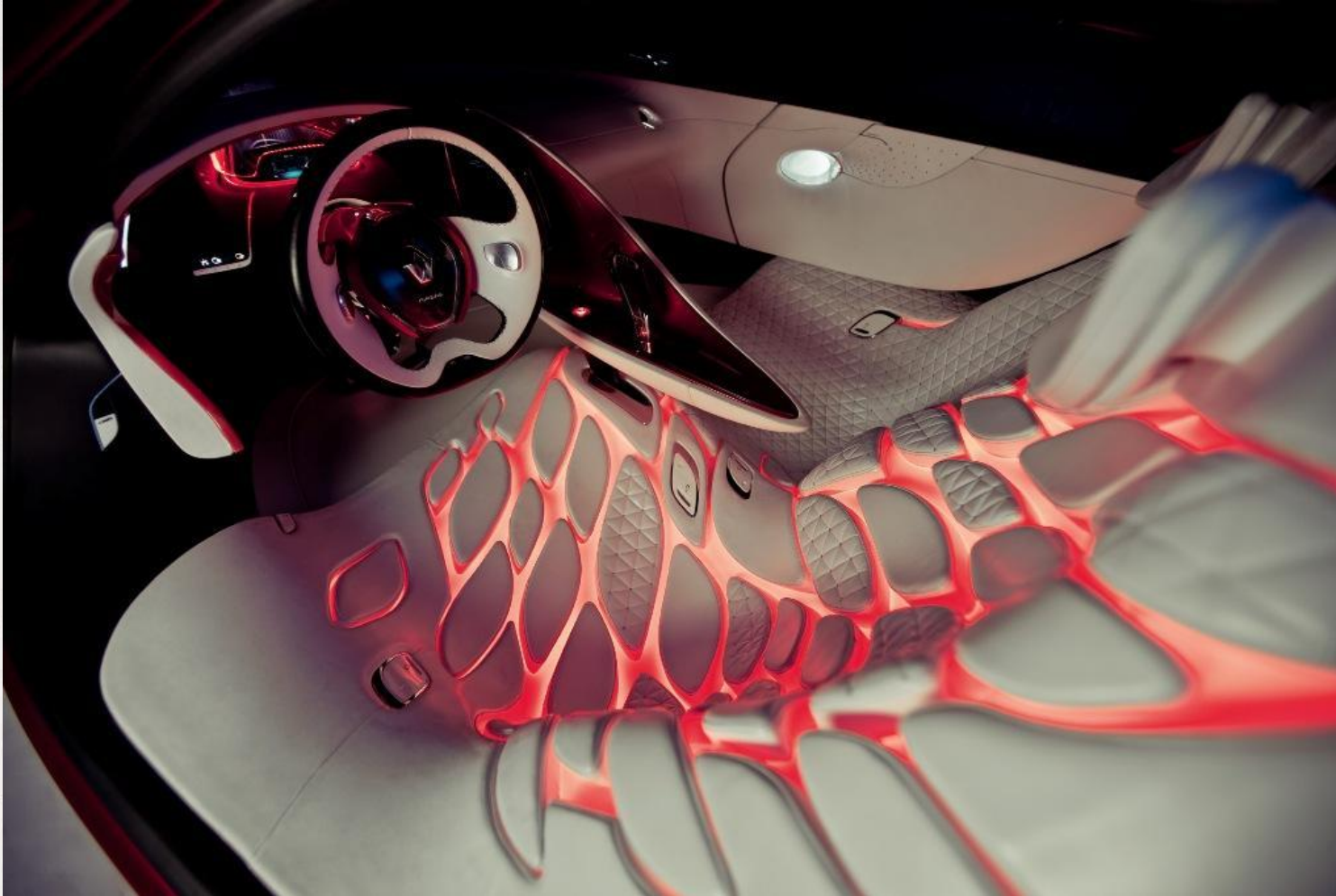

*Biónica*

## Project: #CrepuscularCobra

Later, when the team was defining the mechanical components we had to make small variations, but it was a great opportunity to refine the concept adding a few more details to the final design.



At the end, the #CrepuscularCobra concept was highly recognized in the world of Fsaе and Fstudent, and specially loved in our city, it was even featured in a well known magazine from our city as an unique art car and "university wit on wheels".

# ARTE-SCIENZA

*Ejemplo*

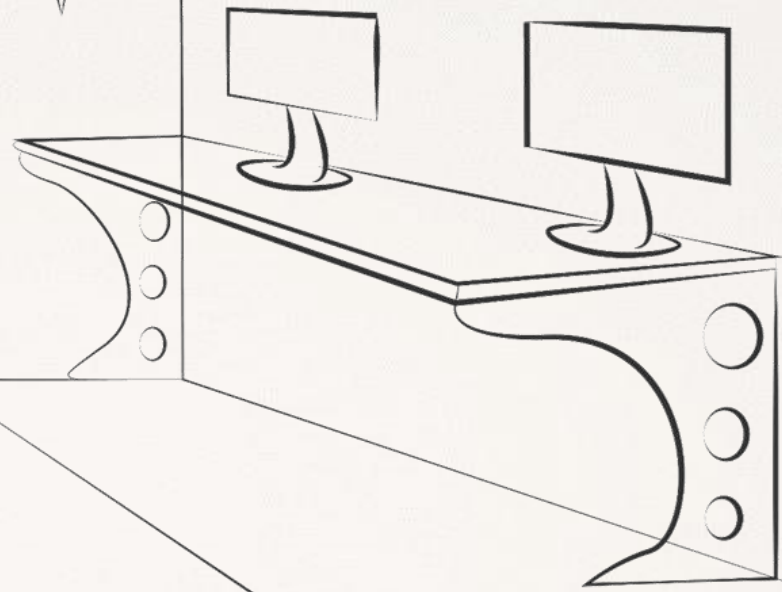
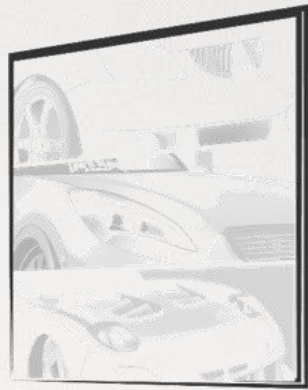
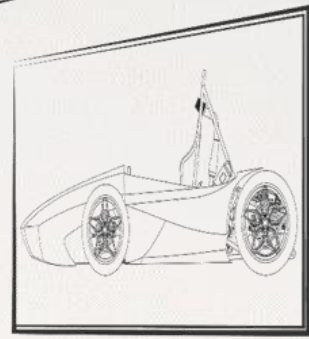
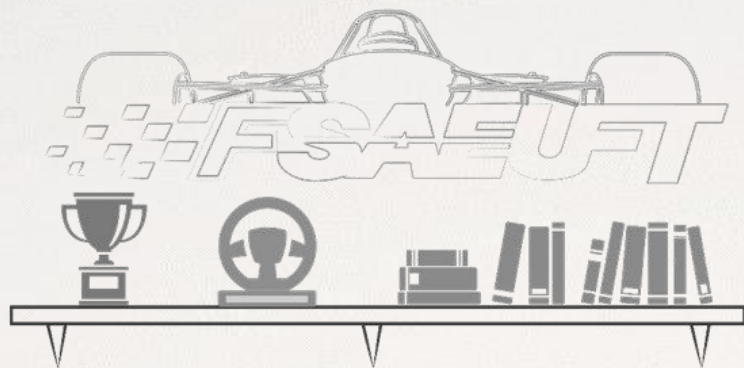

*martine*



*Ejemplo*



# Ejemplo



# Ejemplo

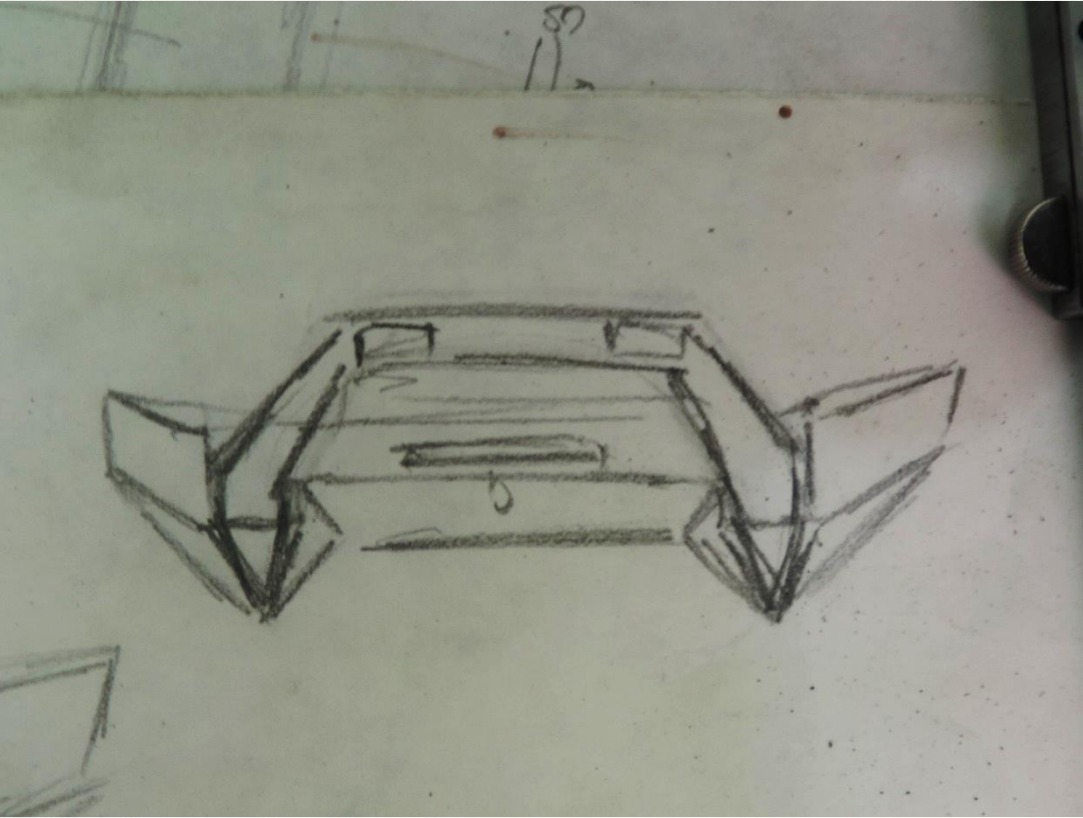

# Project: #MPBoffroad

Later Imur4wd (another important offroad industry from my country) gave me the brief to conceive an unique front bumper with integrated ledbars, a grille guard and a custom roofrack for a special offroad vehicle that they could manage to get from Spain, an Uro Vamtac, which is an heavily armored truck used by the spanish military very similar to the Hummer H1, so that's why part of the brief was to design something that could make it look different from the Hummer and gave it a distinctive personality.

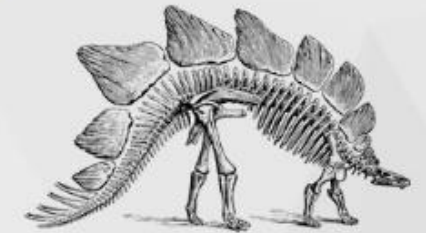

Imur4wd has always painted in white some of their skid plates, which reminds me a zebra combined with the black of the bumpers, and that was a detail that I wanted to integrate.

The #Offroad-Warrior is a project that is actually under construction by Imur4wd and UroVenezuela,



and it's planned to be finished by 2017 and driven by Tony Velazquez from Venezuela to Chile.

When I was drawing the Vamtac's front, I realized the headlights had the same look from a frog so I decided to use that as identity of the project and strengthen that concept with the grille guard, this last one was also inspired by the stegosaurus ribs which was also an armored dinosaur with characteristic plates on top of it, like the roofrack anchorages.

# CORPORALIA

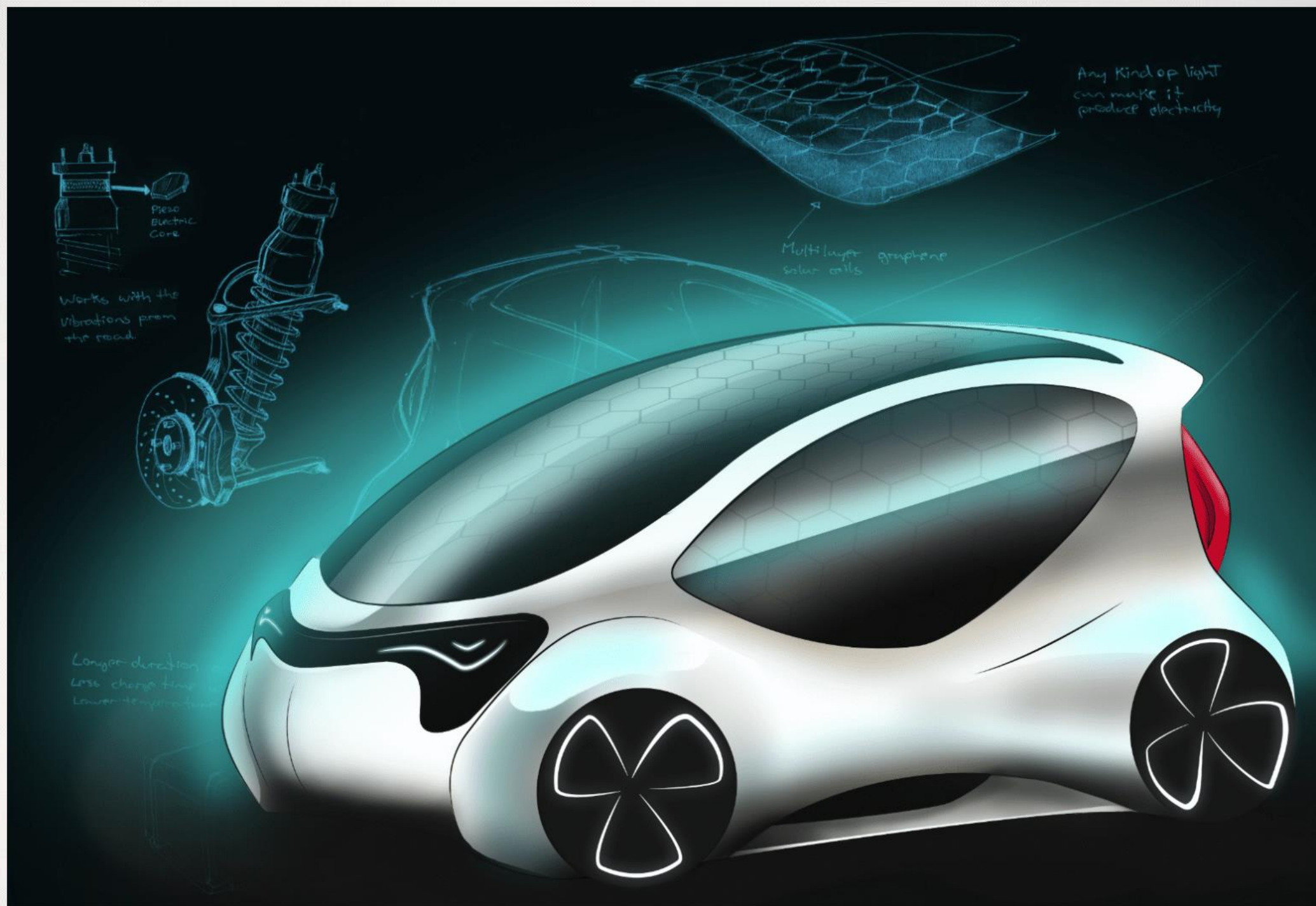
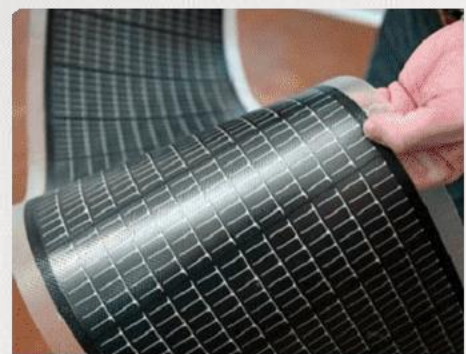
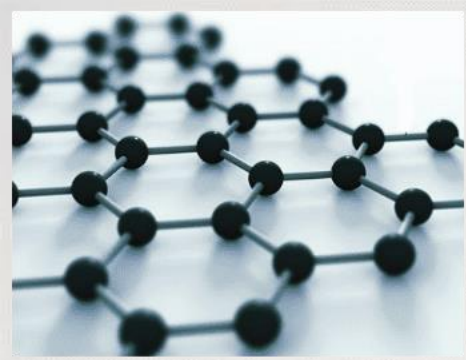

# *Conceptualización*



*Biónica*



A highly sensitive thermochromic paint with an hydrographic polygonal pattern underlayer gives a new definition to the mythical *skin & frame* and brings the *new seppia* to life

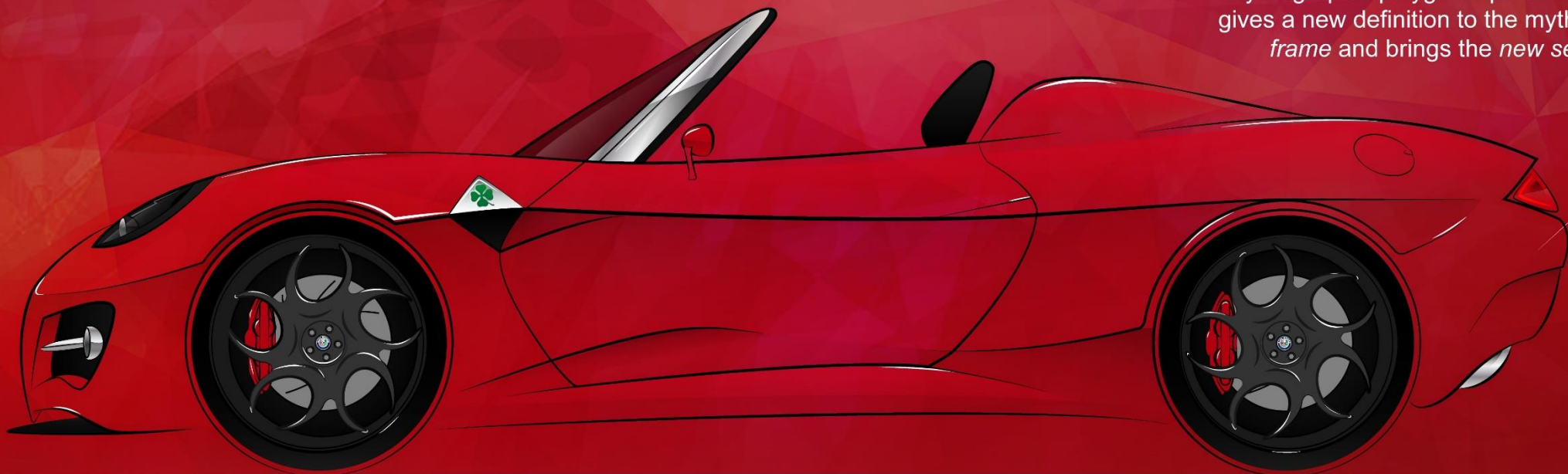

# *Casas de diseño reconocidas*

*Pininfarina*

*Italdesign Guigiaro*

*Bertone*

*Touring Superleggera*

*Zagato*

*Style Torino*

*Fioravanti*

*Kahn design*

*Chris Bangle Associates*

*Venturi*

*Gordon Murray*

*Foose design*

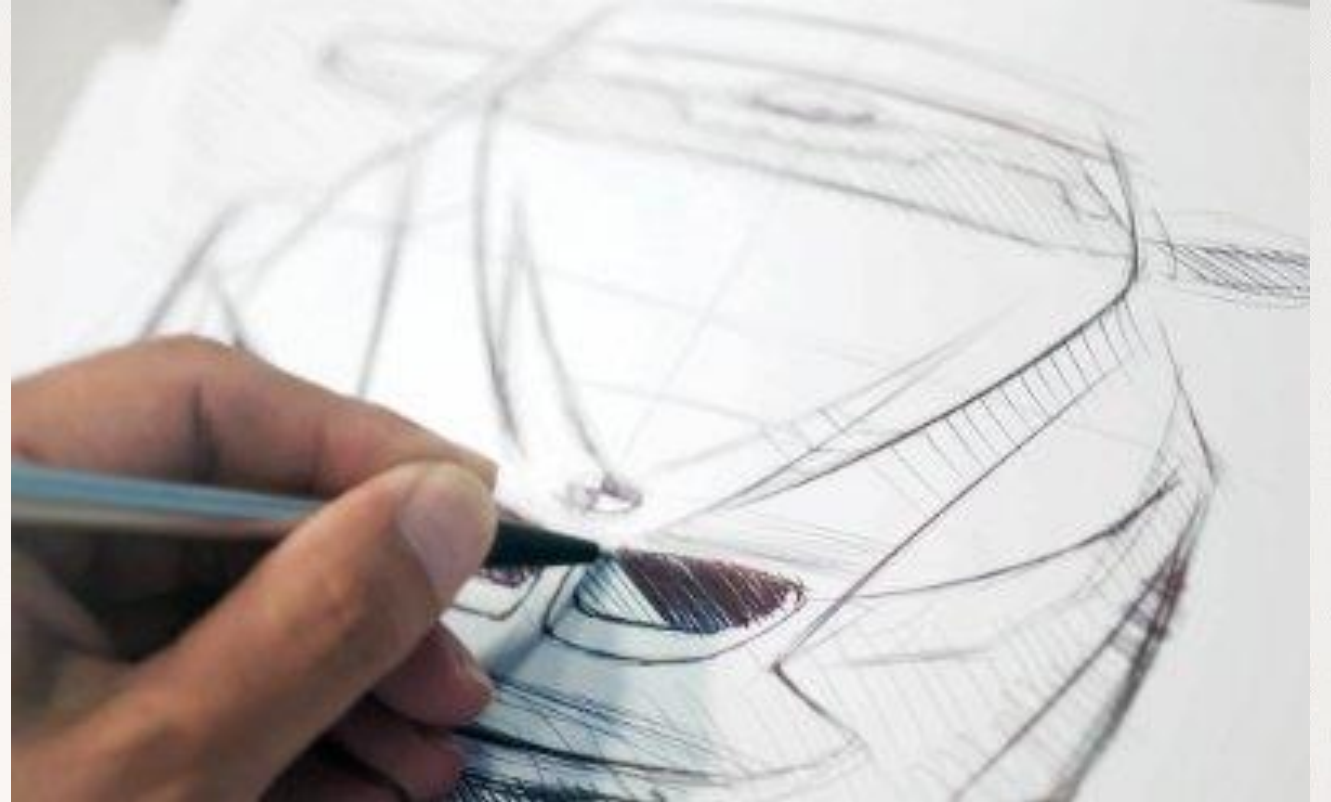



# El Proceso de la industria Automotriz

MPT – Key Milestones:

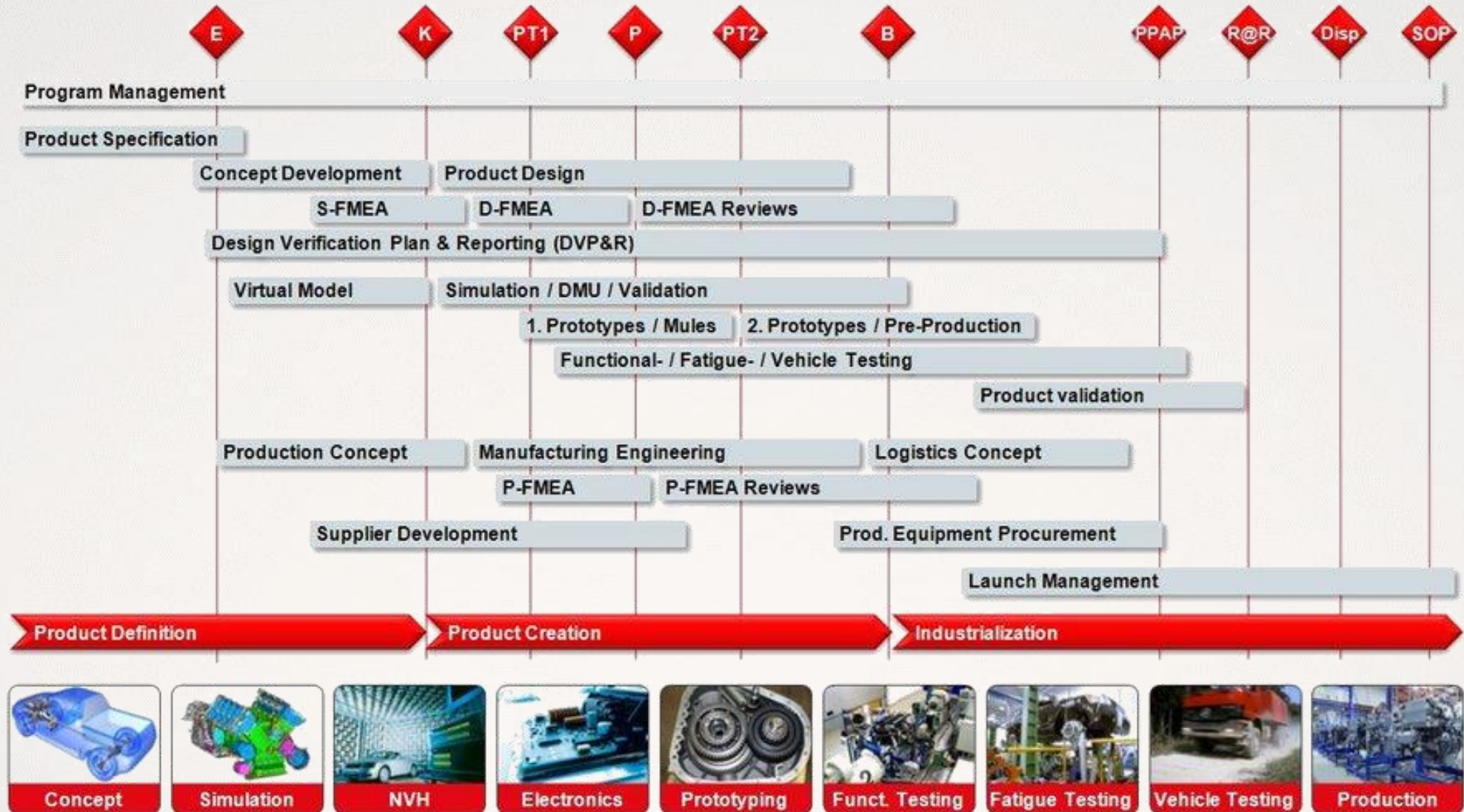

# Mulas



# Mulas?



# El Proceso de la industria Automotriz

- Idea Inicial (1 año o mas)
- Definición del Producto (2do o 3er año)
- Creación del Producto (3er o 4to año)
- Industrialización (4to o 5to año)
- Producción y optimización (5to año en adelante)

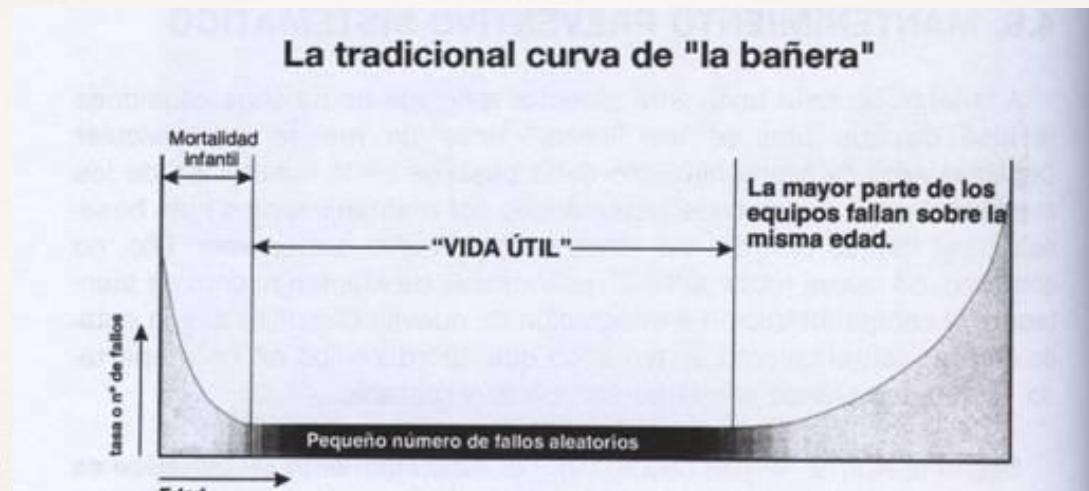

# Facelift & Recall



# *Conclusiones*

*Proceso en Diseño Automotriz: Concepto, Ingeniería, Producción.*

*La conceptualización es libre.*

*Fundamentos para conceptualizar: Proporción y Perspectiva.*

*Concepción de ideas (Biónica y Evolución)*

*Ejemplos de conceptos*

*La mente es como un paracaídas, solo funciona si se abre*

*Albert Einstein*

*[www.DautomotrizUFT.weebly.com](http://www.DautomotrizUFT.weebly.com)*